

Product Category

100-2-CUNI

Part Description

Direct Socketweld/Braze Coupling (Pipe)

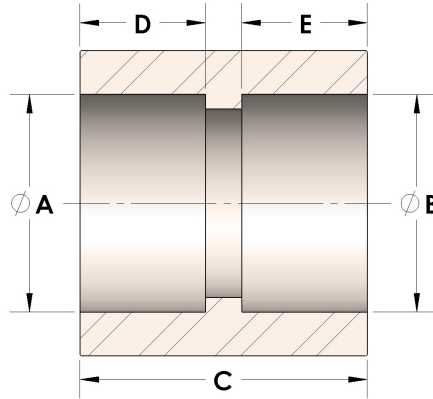

DIMENSIONS

A	0.690
B	0.69
C	1.06
D	0.380
E	0.38

GENERAL

Pressure Rating	4500 PSI
Fitting Material	Copper Nickel 70/30, MIL-C--15726F, UNS C71500