

Product Category

100-2-SS316L

Part Description

Direct Socketweld/Braze Coupling (Pipe)

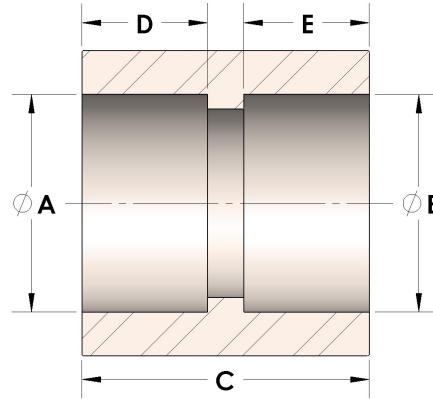

DIMENSIONS

A	0.690
B	0.69
C	1.06
D	0.380
E	0.38

GENERAL

Pressure Rating	6000 PSI
Fitting Material	316/L Stainless Steel, ASTM A276, UNS S31600/03