

Product Category

100-3-2-CUNI

Part Description

Direct Socketweld/Braze Coupling (Pipe)

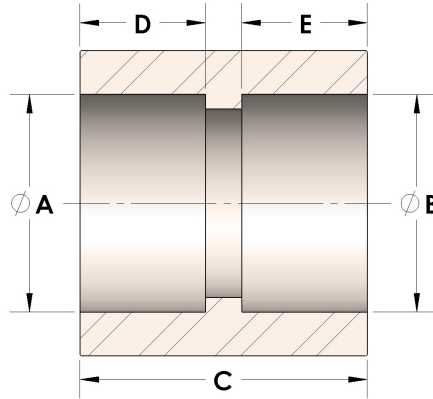

## DIMENSIONS

A	0.855
B	0.69
C	1.38
D	0.500
E	0.44

## GENERAL

Pressure Rating	4500 PSI
Fitting Material	Copper Nickel 70/30, MIL-C--15726F, UNS C71500