

Product Category

100-3-2-M

Part Description

Direct Socketweld/Braze Coupling (Pipe)

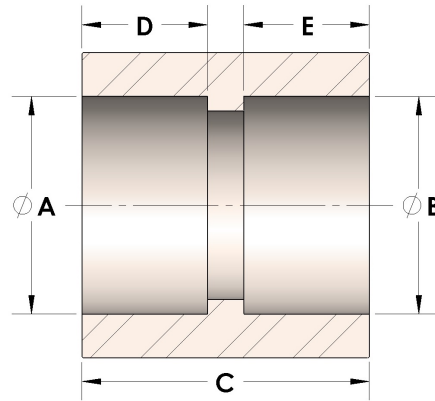

DIMENSIONS

A	0.855
B	0.69
C	1.38
D	0.500
E	0.44

GENERAL

Pressure Rating	6000 PSI
Fitting Material	Monel®, ASTM B164, UNS N04405