

Product Category

100-4-S

Part Description

Direct Socketweld/Braze Coupling (Pipe)

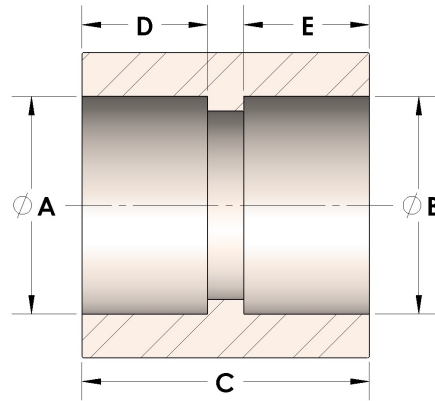

DIMENSIONS

A	1.065
B	1.07
C	1.38
D	0.500
E	0.50

GENERAL

Pressure Rating	6000 PSI
Fitting Material	Carbon Steel, ASTM A108