

Product Category

100-4-SS316L

Part Description

Direct Socketweld/Braze Coupling (Pipe)

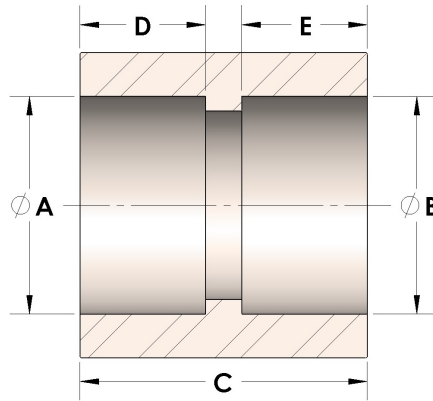

## DIMENSIONS

A	1.065
B	1.07
C	1.38
D	0.500
E	0.50

## GENERAL

Pressure Rating	6000 PSI
Fitting Material	316/L Stainless Steel, ASTM A276, UNS S31600/03