

Product Category

100-6-M

Part Description

Direct Socketweld/Braze Coupling (Pipe)

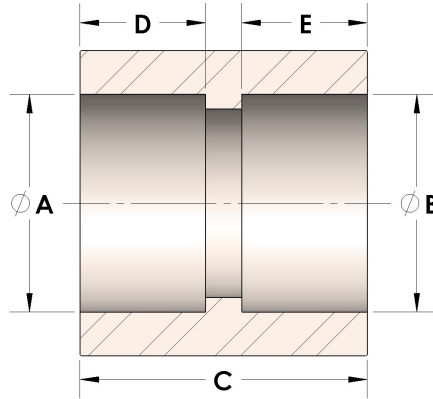

## DIMENSIONS

A	1.675
B	1.68
C	1.50
D	0.500
E	0.50

## GENERAL

Pressure Rating	6000 PSI
Fitting Material	Monel®, ASTM B164, UNS N04405