

Product Category

100-6-SS316L

Part Description

Direct Socketweld/Braze Coupling (Pipe)

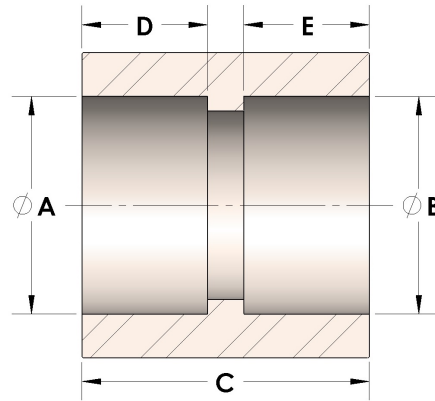

DIMENSIONS

A	1.675
B	1.68
C	1.50
D	0.500
E	0.50

GENERAL

Pressure Rating	6000 PSI
Fitting Material	316/L Stainless Steel, ASTM A276, UNS S31600/03