

Product Category

100-7-CUNI

Part Description

Direct Socketweld/Braze Coupling (Pipe)

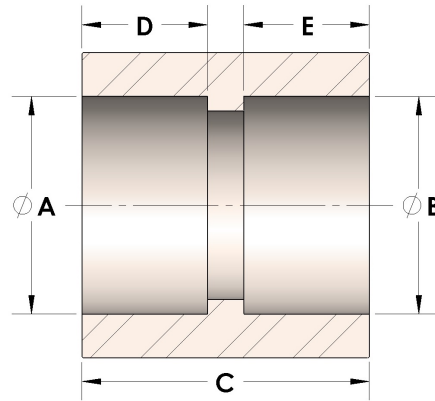

## DIMENSIONS

A	1.915
B	1.92
C	1.50
D	0.500
E	0.50

## GENERAL

Pressure Rating	3000 PSI
Fitting Material	Copper Nickel 70/30, MIL-C--15726F, UNS C71500