

Product Category

100-8-SS316L

Part Description

Direct Socketweld/Braze Coupling (Pipe)

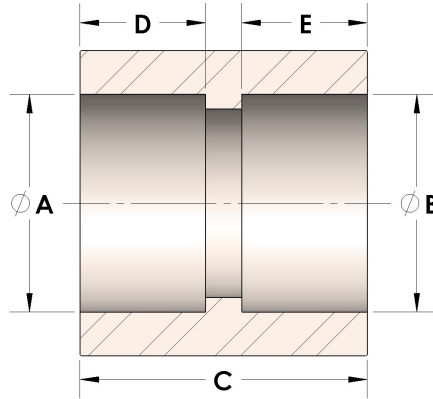

DIMENSIONS

A	2.406
B	2.41
C	2.00
D	0.630
E	0.63

GENERAL

Pressure Rating	4500 PSI
Fitting Material	316/L Stainless Steel, ASTM A276, UNS S31600/03