

Product Category

107-3-04-SS316L

Part Description

Direct Socketweld/Braze Coupling (Pipe X Tube)

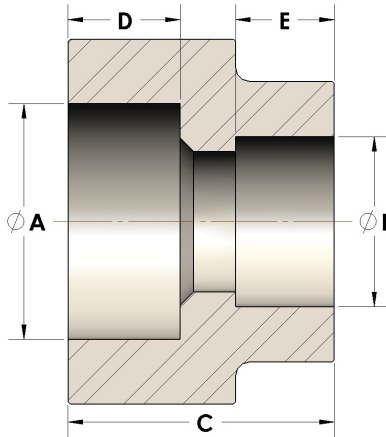

DIMENSIONS

A	0.845
B	0.25
C	1.00
D	0.440

GENERAL

Pressure Rating	6000 PSI
Fitting Material	316/L Stainless Steel, ASTM A276, UNS S31600/03