

Product Category

107-3-06-S

Part Description

Direct Socketweld/Braze Coupling (Pipe X Tube)

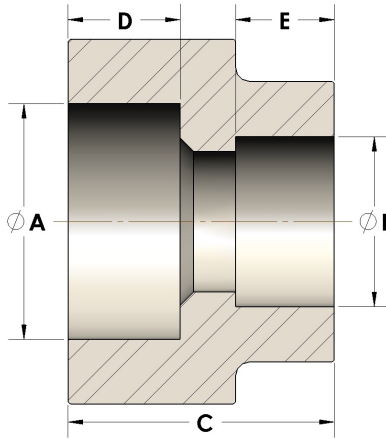

DIMENSIONS

A	0.845
B	0.38
C	1.00
D	0.440

GENERAL

Pressure Rating	6000 PSI
Fitting Material	Carbon Steel, ASTM A108