

Product Category

107-4-12-S

Part Description

Direct Socketweld/Braze Coupling (Pipe X Tube)

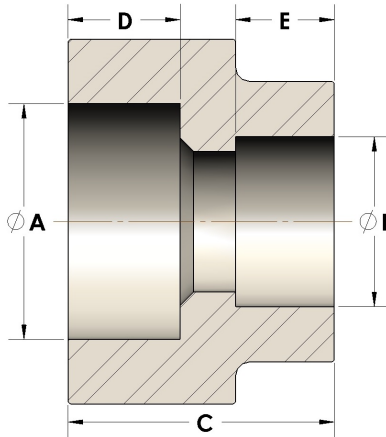

DIMENSIONS

A	1.055
B	0.75
C	1.19
D	0.500

GENERAL

Pressure Rating	6000 PSI
Fitting Material	Carbon Steel, ASTM A108