

Product Category

107-5-08-M

Part Description

Direct Socketweld/Braze Coupling (Pipe X Tube)

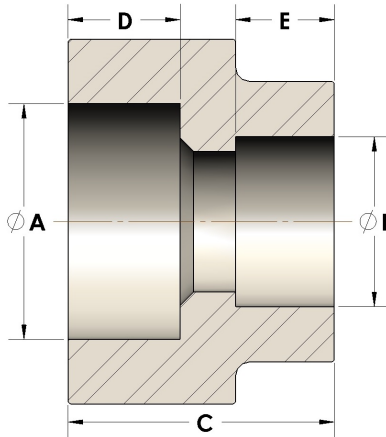

## DIMENSIONS

A	1.320
B	0.50
C	1.31
D	0.560

## GENERAL

Pressure Rating	6000 PSI
Fitting Material	Monel®, ASTM B164, UNS N04405