

Product Category

107-5-16-S

Part Description

Direct Socketweld/Braze Coupling (Pipe X Tube)

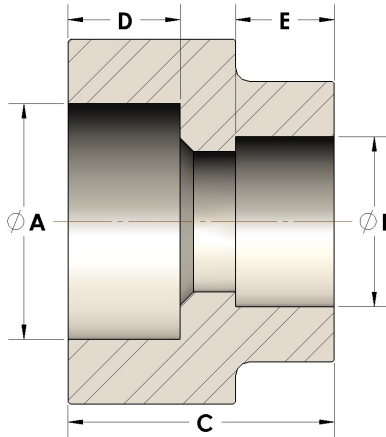

## DIMENSIONS

A	1.320
B	1.00
C	1.31
D	0.560

## GENERAL

Pressure Rating	6000 PSI
Fitting Material	Carbon Steel, ASTM A108