

Product Category

107-6-16-S

Part Description

Direct Socketweld/Braze Coupling (Pipe X Tube)

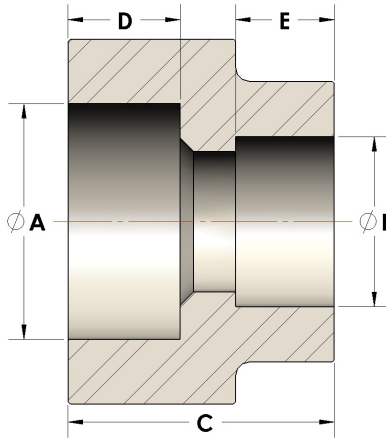

DIMENSIONS

A	1.665
B	1.00
C	1.44
D	0.630

GENERAL

Pressure Rating	6000 PSI
Fitting Material	Carbon Steel, ASTM A108