

Product Category

107-7-24-S

Part Description

Direct Socketweld/Braze Coupling (Pipe X Tube)

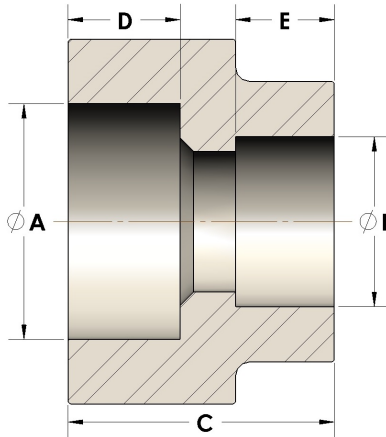

DIMENSIONS

A	1.905
B	1.50
C	1.63
D	0.750

GENERAL

Pressure Rating	4500 PSI
Fitting Material	Carbon Steel, ASTM A108