

Product Category

107-8-32-M

Part Description

Direct Socketweld/Braze Coupling (Pipe X Tube)

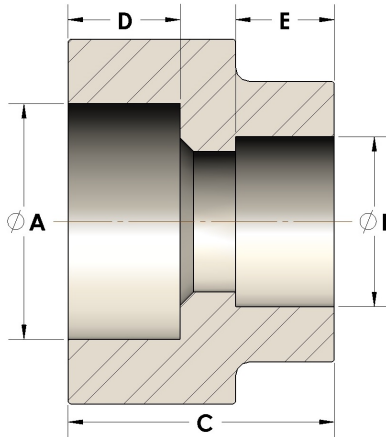

DIMENSIONS

A	2.380
B	2.00
C	2.13
D	0.880

GENERAL

Pressure Rating	6000 PSI
Fitting Material	Monel®, ASTM B164, UNS N04405