

Product Category

381-3

Product Line

O-SEAL® Shutoff Valves (300 Series)

Part Description

1/2" Angle Shutoff Valve with O-SEAL® Ends

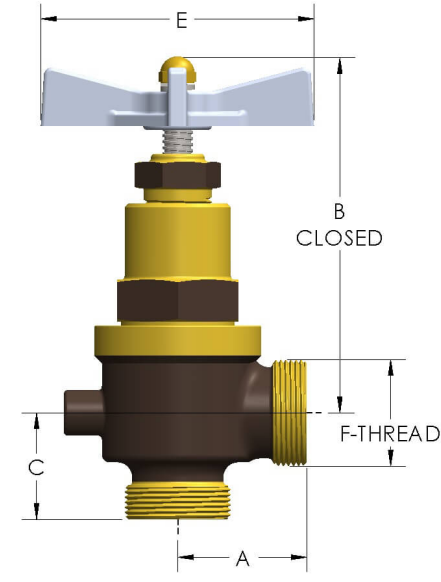

## DIMENSIONS

Port Dia.	0.5
A	2.130
B	5.69
C	1.75
E	4.50
F-THREAD	1.750"-12UN
Lift	0.53



## GENERAL

<b>Pressure Rating</b>	6000 PSI
<b>Temperature Range</b>	-15°F to 275°F (-26°C to 135°C)
<b>Standard Soft Goods</b>	[-G] Polyurethane® Packing and Viton® O-Rings
<b>Cartridge Type</b>	Shutoff
<b>Connection Type</b>	O-SEAL® Union Thread
<b>Connection Size</b>	1/2"
<b>Body Material</b>	Nickel Aluminum Bronze, ASTM B148, UNS C95800
<b>Bonnet Material</b>	Nickel Aluminum Bronze, ASTM B150, UNS C63200

## OPTIONS

<b>[-VC] Vacuum Service</b>	Option to add additional softgoods for internal vacuum service.
<b>[-P] Panel Mount</b>	Option to add external thread and panel mounting nut to bonnet
<b>Port &amp; Vent Options</b>	[-PA] Port Above Seat (1/8" NPT), [-PB] Port Below Seat (1/8" NPT), [-VA] Vent Above Seat (3/8"-24 SAE), [-VB] Vent Below Seat (3/8"-24 SAE),
<b>Optional Soft Goods</b>	[-B] Polyurethane® Packing and Buna-N O-Rings, [-C] Viton® Packing & O-Rings, [-D] EPDM Packing & O-Rings