

Product Category

42-3-S

Part Description

Elbow 45°

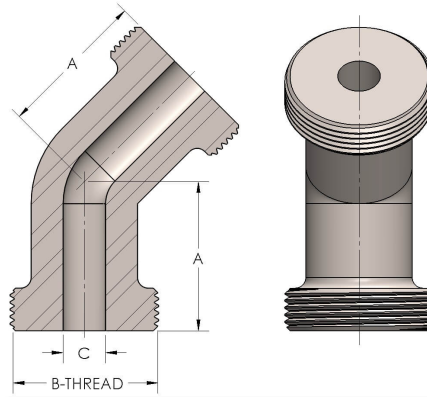

DIMENSIONS

A	1.750
B-THREAD	1.750" - 12UN
C	0.50

GENERAL

Pressure Rating	6000 PSI
Threadpiece Material	Steel, ASTM A216-WCB, UNS J03002