

Product Category

42-5-S

Part Description

Elbow 45°

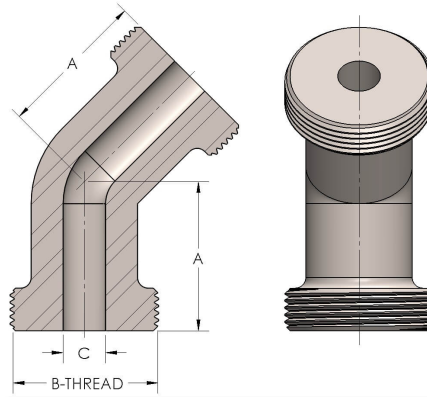

DIMENSIONS

A	2.250
B-THREAD	2.313" - 12UNS
C	0.81

GENERAL

Pressure Rating	6000 PSI
Threadpiece Material	Steel, ASTM A216-WCB, UNS J03002