

Product Category

42-6-S

Part Description

Elbow 45°

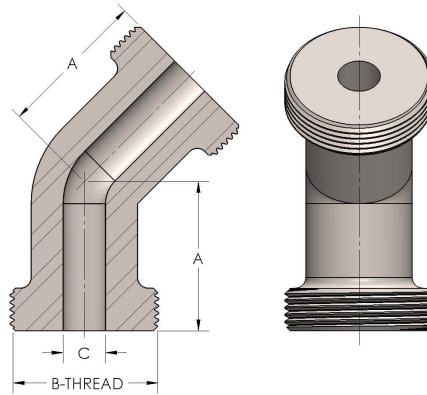

DIMENSIONS

A	2.500
B-THREAD	2.750" - 12UN
C	1.19

GENERAL

Pressure Rating	6000 PSI
Threadpiece Material	Steel, ASTM A216-WCB, UNS J03002