

Product Category

43-3-NAB

Part Description

Cross

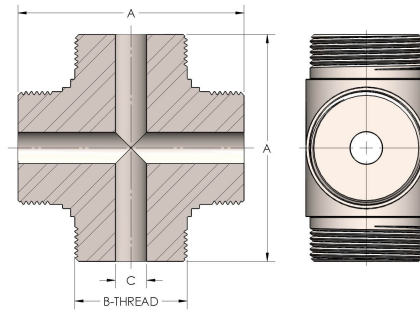

DIMENSIONS

A	3.500
B-THREAD	1.750" - 12UN
C	0.50
D	1.750

GENERAL

Pressure Rating	6000 PSI
Threadpiece Material	Nickel Aluminum Bronze, ASTM B148, UNS C95800