

Product Category

43-4-S

Part Description

Cross

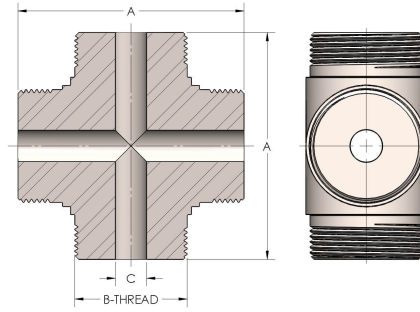

## DIMENSIONS

<b>A</b>	3.750
<b>B-THREAD</b>	2.000" - 12UN
<b>C</b>	0.63
<b>D</b>	1.880

## GENERAL

<b>Pressure Rating</b>	6000 PSI
<b>Threadpiece Material</b>	Steel, ASTM A216-WCB, UNS J03002