

Product Category

43-6-NAB

Part Description

Cross

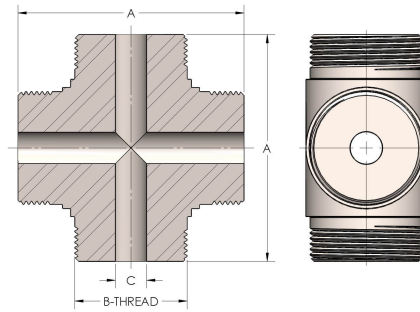

## DIMENSIONS

<b>A</b>	5.000
<b>B-THREAD</b>	2.750" - 12UN
<b>C</b>	1.19
<b>D</b>	2.500

## GENERAL

<b>Pressure Rating</b>	6000 PSI
<b>Threadpiece Material</b>	Nickel Aluminum Bronze, ASTM B148, UNS C95800