

Product Category

43-6-SS316L

Part Description

Cross

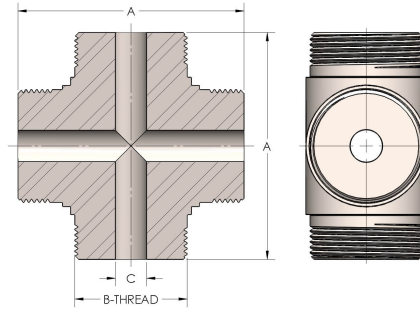

DIMENSIONS

A	5.000
B-THREAD	2.750" - 12UN
C	1.19
D	2.500

GENERAL

Pressure Rating	6000 PSI
Threadpiece Material	316 Stainless Steel, ASTM A351, UNS J92900