

Product Category

45-2-06-SS316L

Part Description

Direct Socketweld/Braze Pipe X Male Straight Thread Adapter

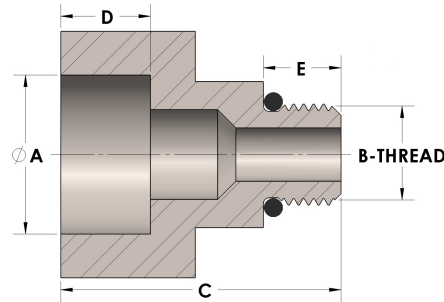

DIMENSIONS

A	0.690
B-THREAD	.563"-18UNF
C	1.50
D	0.440
E	0.43

GENERAL

Pressure Rating	6000 PSI
O-Ring Material	Viton® Fluorocarbon Type 1, Class 2 (90 durometer)
Fitting Material	316/L Stainless Steel, ASTM A276, UNS S31600/03