

Product Category

45-3-04-M

Part Description

Direct Socketweld/Braze Pipe X Male Straight Thread Adapter

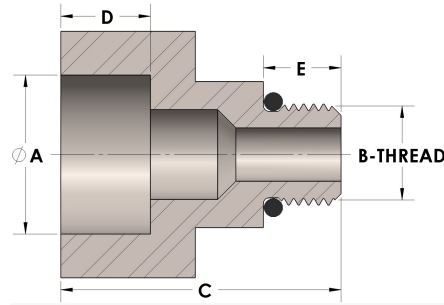

## DIMENSIONS

A	0.855
B-THREAD	.438"-20UNF
C	1.50
D	0.500
E	0.41

## GENERAL

Pressure Rating	6000 PSI
O-Ring Material	Viton® Fluorocarbon Type 1, Class 2 (90 durometer)
Fitting Material	Monel®, ASTM B164, UNS N04405