

Product Category

45-5-12-S

Part Description

Direct Socketweld/Braze Pipe X Male Straight Thread Adapter

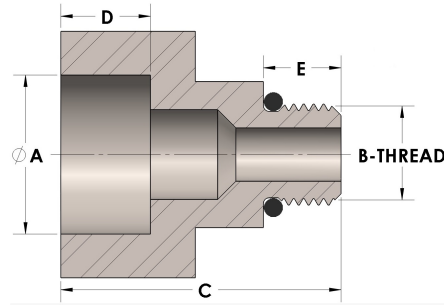

DIMENSIONS

A	1.330
B-THREAD	1.063"-12UN
C	2.00
D	0.630
E	0.63

GENERAL

Pressure Rating	6000 PSI
O-Ring Material	Viton® Fluorocarbon Type 1, Class 2 (90 durometer)
Fitting Material	Carbon Steel, ASTM A108