

Product Category

45-5-16-SS316L

Part Description

Direct Socketweld/Braze Pipe X Male Straight Thread Adapter

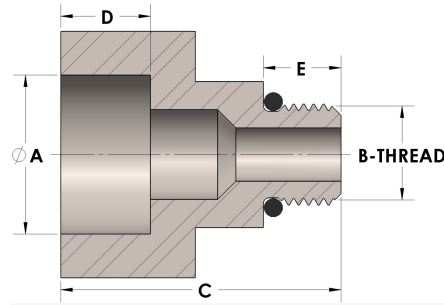

DIMENSIONS

A	1.330
B-THREAD	1.313"-12UN
C	1.63
D	0.500
E	0.63

GENERAL

Pressure Rating	6000 PSI
O-Ring Material	Viton® Fluorocarbon Type 1, Class 2 (90 durometer)
Fitting Material	316/L Stainless Steel, ASTM A276, UNS S31600/03