

Product Category

45-6-24-S

Part Description

Direct Socketweld/Braze Pipe X Male Straight Thread Adapter

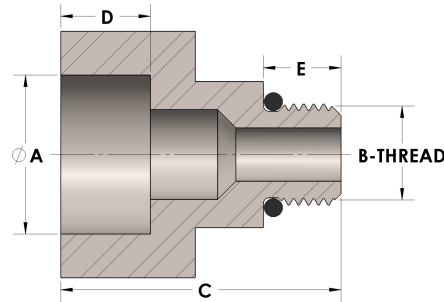

## DIMENSIONS

A	1.675
B-THREAD	1.875"-12UN
C	2.00
D	0.690
E	0.63

## GENERAL

Pressure Rating	4500 PSI
O-Ring Material	Viton® Fluorocarbon Type 1, Class 2 (90 durometer)
Fitting Material	Carbon Steel, ASTM A108