

Product Category

471-1

Product Line

O-SEAL® Needle Valves (400 Series)

Part Description

1/4" Angle Needle Valve with Welded Ends

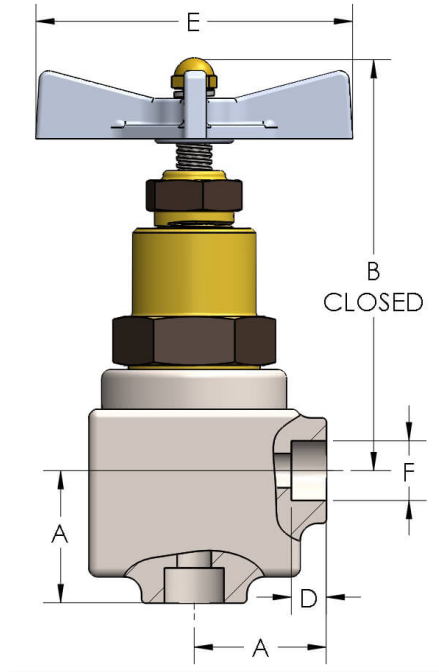

## DIMENSIONS

Port Dia.	0.31
A	1.500
B	3.81
D	0.380
E	3.50
F (Pipe Size)	0.555
F (Tube Size)	0.377
Lift	0.34



## GENERAL

<b>Pressure Rating</b>	6000 PSI
<b>Temperature Range</b>	-15°F to 275°F (-26°C to 135°C)
<b>Standard Soft Goods</b>	[-G] Polyurethane® Packing and Viton® O-Rings
<b>Cartridge Type</b>	Needle
<b>Connection Type</b>	Socketweld
<b>Connection Size</b>	1/4"
<b>Body Material</b>	316/L Stainless Steel, ASTM A276, UNS S31603
<b>Bonnet Material</b>	Nickel Aluminum Bronze, ASTM B150, UNS C63200

## OPTIONS

<b>[-VC] Vacuum Service</b>	Option to add additional softgoods for internal vacuum service.
<b>[-P] Panel Mount</b>	Option to add external thread and panel mounting nut to bonnet
<b>Port &amp; Vent Options</b>	[-PA] Port Above Seat (1/8" NPT), [-PB] Port Below Seat (1/8" NPT), [-VA] Vent Above Seat (3/8"-24 SAE), [-VB] Vent Below Seat (3/8"-24 SAE),
<b>Optional Soft Goods</b>	[-B] Polyurethane® Packing and Buna-N O-Rings, [-C] Viton® Packing & O-Rings, [-D] EPDM Packing & O-Rings