

Product Category

482-3

Product Line

O-SEAL® Needle Valves (400 Series)

Part Description

1/2" Offset Needle Valve with O-SEAL® Ends

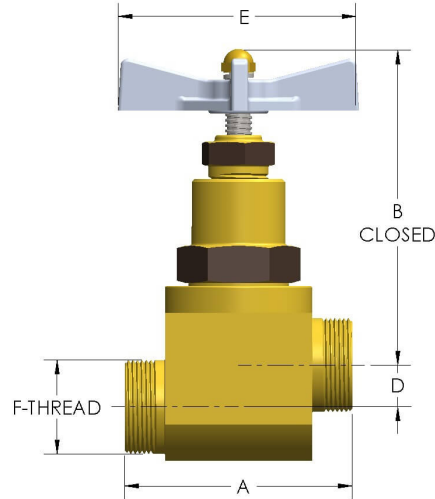

DIMENSIONS

Port Dia.	0.5
A	4.250
B	6.00
D	0.780
E	4.50
F-THREAD	1.750"-12UN
Lift	0.53



GENERAL

Pressure Rating	6000 PSI
Temperature Range	-15°F to 275°F (-26°C to 135°C)
Standard Soft Goods	[-G] Polyurethane® Packing and Viton® O-Rings
Cartridge Type	Needle
Connection Type	O-SEAL® Union Thread
Connection Size	1/2"
Body Material	Nickel Aluminum Bronze, ASTM B150, UNS C63200
Bonnet Material	Nickel Aluminum Bronze, ASTM B150, UNS C63200

OPTIONS

[-VC] Vacuum Service	Option to add additional softgoods for internal vacuum service.
[-P] Panel Mount	Option to add external thread and panel mounting nut to bonnet
Port & Vent Options	[-PA] Port Above Seat (1/8" NPT), [-PB] Port Below Seat (1/8" NPT), [-VA] Vent Above Seat (3/8"-24 SAE), [-VB] Vent Below Seat (3/8"-24 SAE),
Optional Soft Goods	[-B] Polyurethane® Packing and Buna-N O-Rings, [-C] Viton® Packing & O-Rings, [-D] EPDM Packing & O-Rings