

Product Category

57-4-2-S

Part Description

Direct Weld/Braze Insert (Male Pipe X Pipe SW)

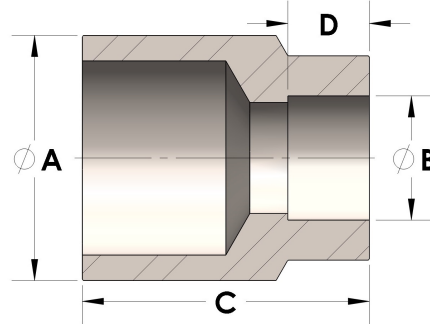

DIMENSIONS

A	1.050
B	0.69
C	1.63
D	0.440

GENERAL

Pressure Rating	6000 PSI
Fitting Material	Carbon Steel, ASTM A108