

Product Category

57-5-3-S

Part Description

Direct Weld/Braze Insert (Male Pipe X Pipe SW)

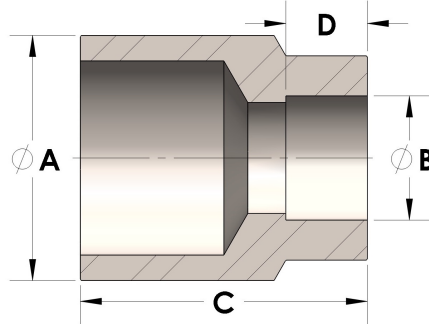

DIMENSIONS

A	1.315
B	0.86
C	1.75
D	0.500

GENERAL

Pressure Rating	6000 PSI
Fitting Material	Carbon Steel, ASTM A108