

Product Category

57-6-3-M

Part Description

Direct Weld/Braze Insert (Male Pipe X Pipe SW)

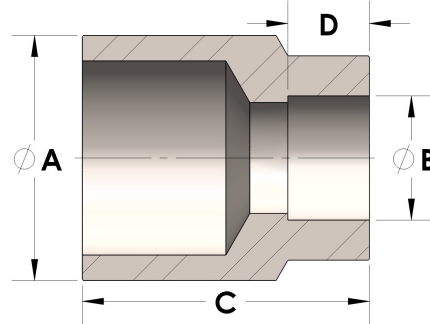

DIMENSIONS

A	1.660
B	0.86
C	1.88
D	0.500

GENERAL

Pressure Rating	6000 PSI
Fitting Material	Monel®, ASTM B164, UNS N04405