

Product Category

57-6-3-SS316L

Part Description

Direct Weld/Braze Insert (Male Pipe X Pipe SW)

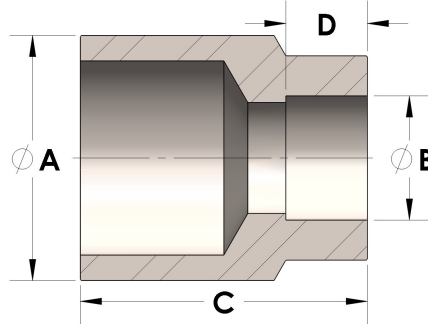

DIMENSIONS

A	1.660
B	0.86
C	1.88
D	0.500

GENERAL

Pressure Rating	6000 PSI
Fitting Material	316/L Stainless Steel, ASTM A276, UNS S31600/03