

Product Category

57-6-4-SS316L

Part Description

Direct Weld/Braze Insert (Male Pipe X Pipe SW)

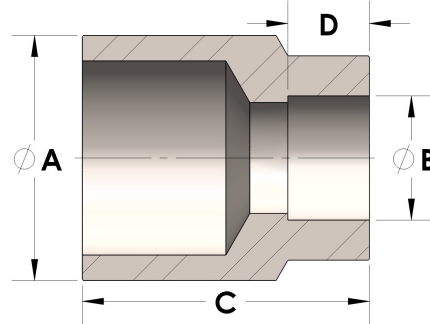

## DIMENSIONS

A	1.660
B	1.07
C	1.94
D	0.560

## GENERAL

Pressure Rating	6000 PSI
Fitting Material	316/L Stainless Steel, ASTM A276, UNS S31600/03