

Product Category

57-8-5-S

Part Description

Direct Weld/Braze Insert (Male Pipe X Pipe SW)

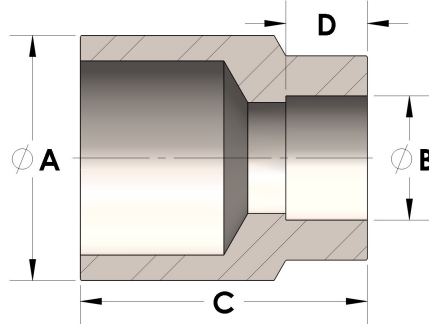

DIMENSIONS

A	2.375
B	1.33
C	2.25
D	0.630

GENERAL

Pressure Rating	6000 PSI
Fitting Material	Carbon Steel, ASTM A108