

Product Category

57-8-6-S

Part Description

Direct Weld/Braze Insert (Male Pipe X Pipe SW)

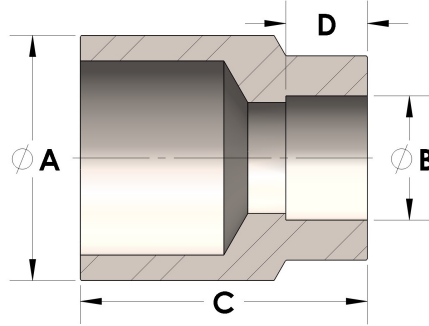

## DIMENSIONS

A	2.375
B	1.68
C	2.38
D	0.690

## GENERAL

Pressure Rating	6000 PSI
Fitting Material	Carbon Steel, ASTM A108