

Product Category

57-8-7-S

Part Description

Direct Weld/Braze Insert (Male Pipe X Pipe SW)

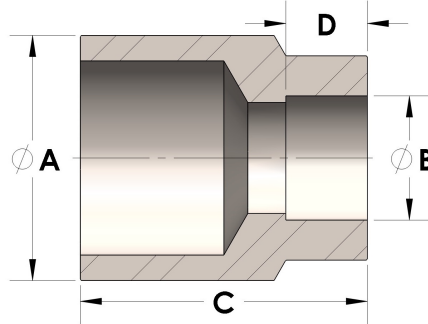

DIMENSIONS

A	2.375
B	1.92
C	2.81
D	0.750

GENERAL

Pressure Rating	6000 PSI
Fitting Material	Carbon Steel, ASTM A108