

Product Category

570-4

Product Line

O-SEAL® Stop-Check Valves (500 Series)

Part Description

3/4" Globe Stop-Check Valve with Welded Ends

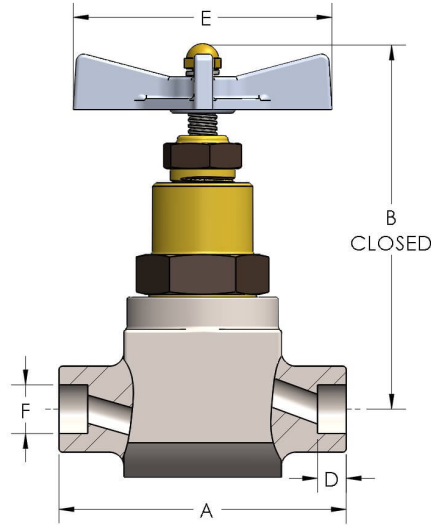

DIMENSIONS

Port Dia.	0.63
A	5.380
B	6.25
D	0.560
E	5.25
F (Pipe Size)	1.065
F (Tube Size)	1.002
Lift	0.56



GENERAL

Pressure Rating	6000 PSI
Temperature Range	-15°F to 275°F (-26°C to 135°C)
Standard Soft Goods	[-G] Polyurethane® Packing and Viton® O-Rings
Cartridge Type	Stop-Check
Connection Type	Socketweld
Connection Size	3/4"
Body Material	316/L Stainless Steel, ASTM A276, UNS S31603
Bonnet Material	Nickel Aluminum Bronze, ASTM B150, UNS C63200

OPTIONS

[-VC] Vacuum Service	Option to add additional softgoods for internal vacuum service.
[-P] Panel Mount	Option to add external thread and panel mounting nut to bonnet
Port & Vent Options	[-PA] Port Above Seat (1/4" NPT), [-PB] Port Below Seat (1/4" NPT), [-VA] Vent Above Seat (1/2"-13 SAE), [-VB] Vent Below Seat (1/2"-13 SAE),
Optional Soft Goods	[-B] Polyurethane® Packing and Buna-N O-Rings, [-C] Viton® Packing & O-Rings, [-D] EPDM Packing & O-Rings