

Product Category

Product Line

Part Description

580-1-P-OXNB-VC

OXNB Stop-Check Valve (500 Series)

1/4" Globe Stop-Check Oxygen Hand Valve

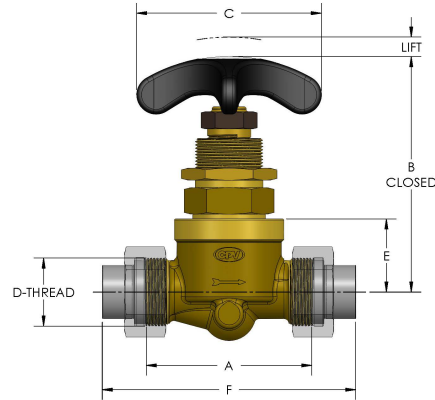

DIMENSIONS

Port Dia.	0.31
A	3.380
B	4.06
C	3.50
CRN	0C16868.2
D-THREAD	1.188"-12UN
E	2.00
F	5.50
Lift	0.34



GENERAL

Pressure Rating	4500 PSI
Temperature Range	-15°F to 400°F (-26°C to 204°C)
Standard Soft Goods	[-C] Viton® Packing & O-Rings
Cartridge Type	Stop-Check
Connection Type	O-SEAL® Union Thread
Connection Size	1/4"
Body Material	Naval Brass, ASTM B21, UNS C46400
Bonnet Material	Naval Brass, ASTM B21, UNS C46400
CRN	OC16868.2

OPTIONS

Port & Vent Options	[-PA] Port Above Seat (1/8" NPT), [-PB] Port Below Seat (1/8" NPT), [-VA] Vent Above Seat (3/8"-24 SAE), [-VB] Vent Below Seat (3/8"-24 SAE),
--------------------------------	---