

Product Category
Product Line
Part Description

8-04NAU-02
Mark VIII® Regulating Valve (8-N Series)
Angle Shutoff Valve with Mark VIII® Ends

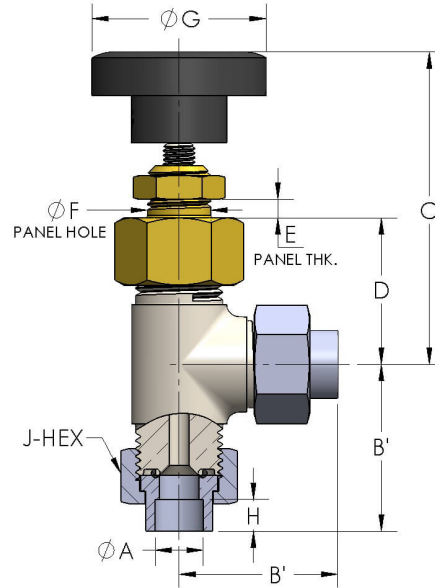

DIMENSIONS

Orifice	0.156
A	0.130
B'	1.19
C (Open)	2.59
C (Closed)	2.44
D	1.220
E	0.25
F	0.53
G	1.38
H	0.19
J-HEX	0.63



GENERAL

Pressure Rating	3000 PSI
Temperature Range	-15°F to 400°F (-26°C to 204°C)
Standard Soft Goods	[-C] Viton® O-Rings
Cartridge Type	Regulating
Connection Type	Mark VIII® Union Thread
Tube O.D.	1/8"
Body Material	316/L Stainless Steel, ASTM A276, UNS S31603
Bonnet Material	Nickel Aluminum Bronze, ASTM B150, UNS C63200

OPTIONS

Optional Soft Goods	[-B] Buna-N O-Rings, [-D] EPDM O-Rings
----------------------------	--