

Product Category

Product Line

Part Description

8-04NGU-06

Mark VIII® Regulating Valve (8-N Series)

In-line Shutoff Valve with Mark VIII® Ends

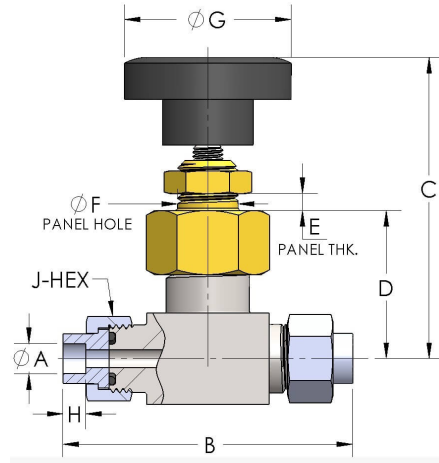

DIMENSIONS

Orifice	0.156
A	0.380
B	3.00
C (Open)	2.59
C (Closed)	2.44
D	1.220
E	0.25
F	0.53
G	1.38
H	0.25
J-HEX	0.81



GENERAL

Pressure Rating	3000 PSI
Temperature Range	-15°F to 400°F (-26°C to 204°C)
Standard Soft Goods	[-C] Viton® O-Rings
Cartridge Type	Regulating
Connection Type	Mark VIII® Union Thread
Tube O.D.	3/8"
Body Material	316/L Stainless Steel, ASTM A276, UNS S31603
Bonnet Material	Nickel Aluminum Bronze, ASTM B150, UNS C63200

OPTIONS

Optional Soft Goods	[-B] Buna-N O-Rings, [-D] EPDM O-Rings
----------------------------	--