

Product Category

89T-1-SS316L

Part Description

Bulkhead

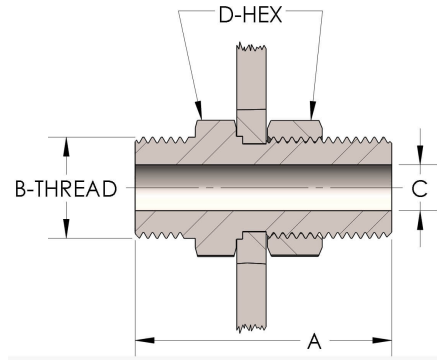

DIMENSIONS

A	2.440
B-THREAD	1.188" - 12UN
C	0.31
D-HEX	1.5

GENERAL

Pressure Rating	6000 PSI
Threadpiece Material	316/L Stainless Steel, ASTM A276, UNS S31600/03