

Product Category

89T-3-S

Part Description

Bulkhead

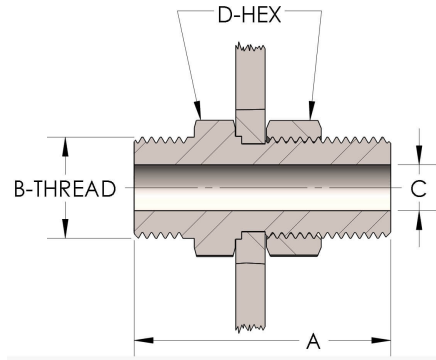

## DIMENSIONS

<b>A</b>	2.440
<b>B-THREAD</b>	1.750" - 12UN
<b>C</b>	0.50
<b>D-HEX</b>	2.13

## GENERAL

<b>Pressure Rating</b>	6000 PSI
<b>Threadpiece Material</b>	Carbon Steel, ASTM A108