

Product Category

89T-4-S

Part Description

Bulkhead

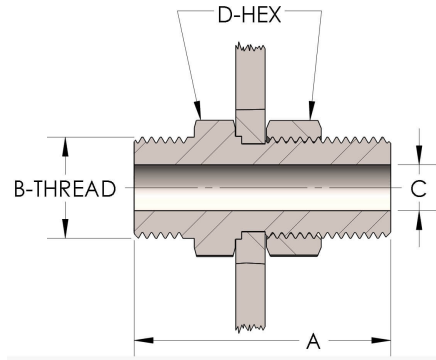

DIMENSIONS

A	2.440
B-THREAD	2.000" - 12UN
C	0.63
D-HEX	2.5

GENERAL

Pressure Rating	6000 PSI
Threadpiece Material	Carbon Steel, ASTM A108