

Product Category

89T-7-SS316L

Part Description

Bulkhead

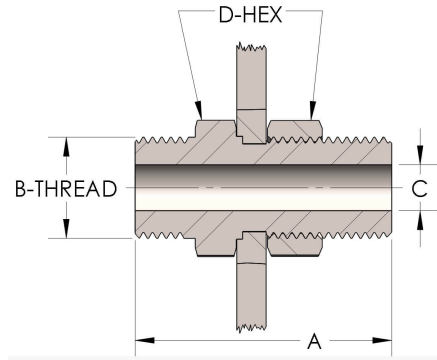

DIMENSIONS

A	3.440
B-THREAD	3.063" - 12UNS
C	1.38
D-HEX	3.63

GENERAL

Pressure Rating	6000 PSI
Threadpiece Material	316/L Stainless Steel, ASTM A276, UNS S31600/03