

Product Category

89T-8-BR

Part Description

Bulkhead

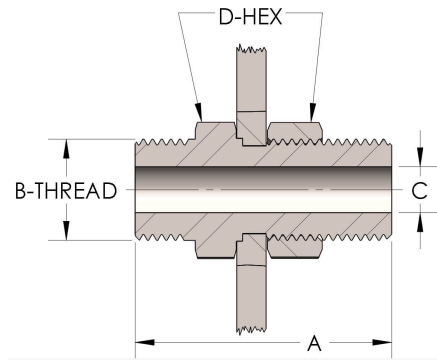

DIMENSIONS

A	3.440
B-THREAD	3.750" - 12UN
C	1.75
D-HEX	4.25

GENERAL

Pressure Rating	6000 PSI
Threadpiece Material	Naval Brass, ASTM B21, UNS C46400